

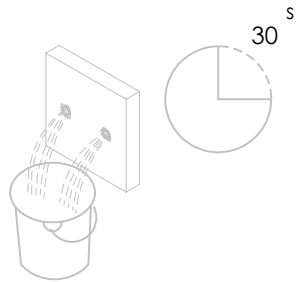

ESC. 1:2	Monocomando Misturador Bancada			
Desenhou 17/11/2020	 A S M T A P S [®]			BIA110A
Rev: 1 21/03/2022	<small>W A T E R S O U L</small>			

Service:

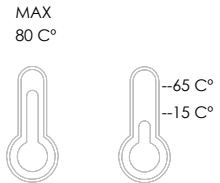
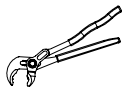

-  Adjustable Pliers
-  18-19 / 24-25
-  2mm

Washbasin Mixer Installation Manual

2°

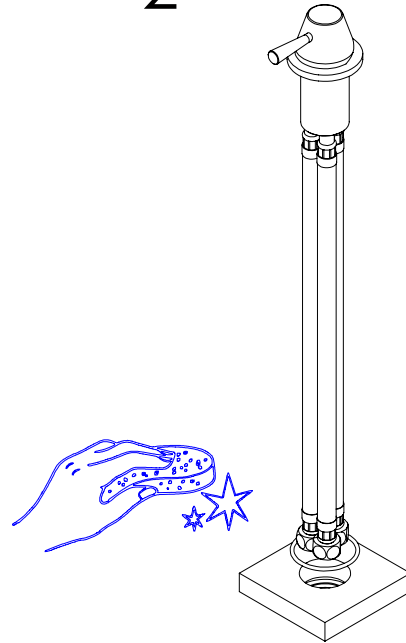

3°

Fixed:

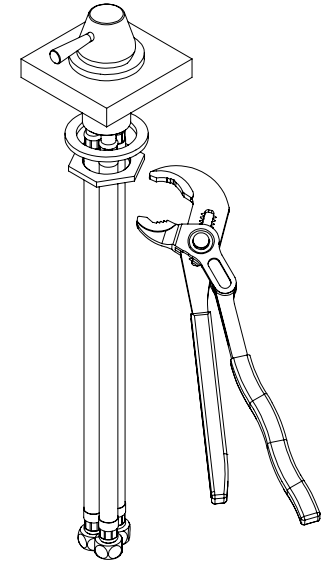

4°

Conection:

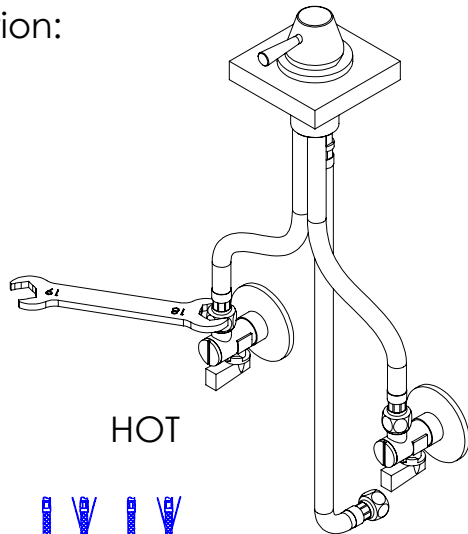

HOT

COLD

5°

Maintenance:

