

| | | | | |
|------------------------|--|--|--|--------|
| ESC. 1:3 | Monocomando Lavatório Alto | | | |
| Desenhou 16/11/2022 |  A S M T A P S [®] WATER SOUL | | | LUX050 |
| Rev: 16/11/2022 | | | | |

Service:



MAX 80 C°



-65 C°
-15 C°

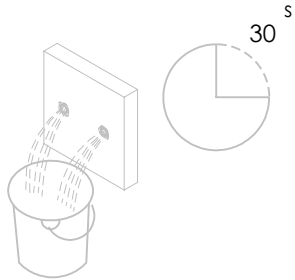

11mm



18/19 - 24/25



Special Key 16,5



2mm

Washbasin Mixer Installation Manual

2°

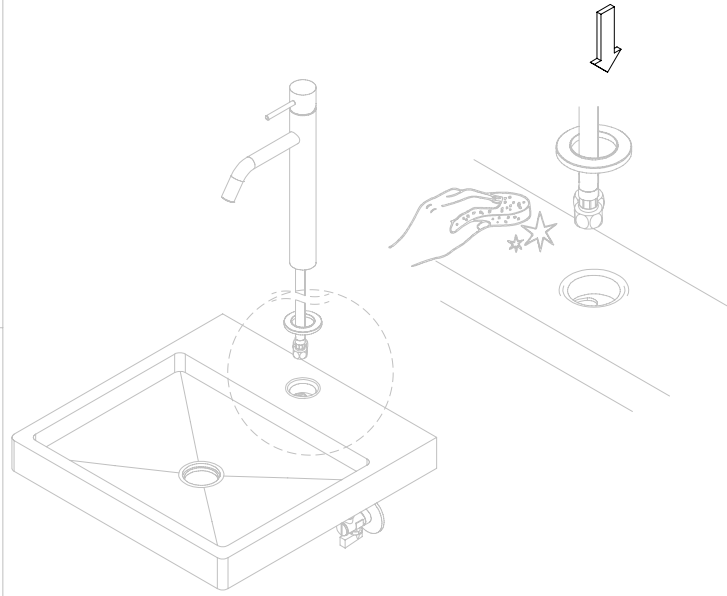

3°

Fixed:

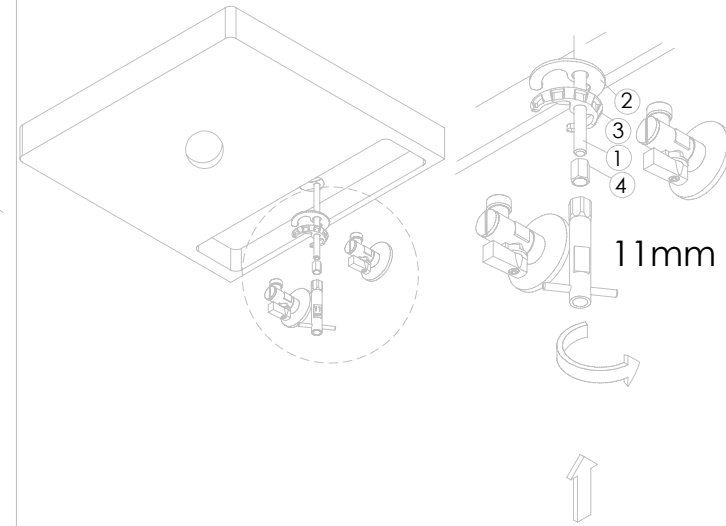

4°

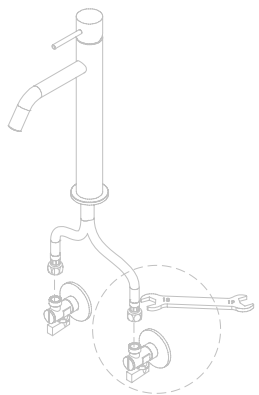

18mm

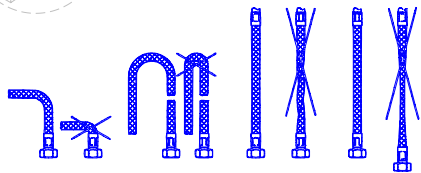
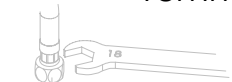

5°

Maintenance:

